

LED Product Information and Warnings

Important

- **Always disconnect the power before installing or replacing bulbs and before cleaning or other maintenance.**
- **Consult a qualified, licensed electrician to ensure correct branch circuit conductor.**
- Please read all included assembly instructions and warnings carefully before installation. Contact Customer Service if you have any questions or concerns. Before installation, please confirm that the fixture is compatible with your supply voltage and dimming system, if present.
- LEDs are highly sensitive electronic devices, and must be treated with care. Do not open any factory sealed compartments, and avoid touching the LEDs with your hands or any object.
- Although all our fixtures are equipped with protective devices, LED fixtures are vulnerable to power surges and supply variations. Do not install LED fixtures on the same circuit as any motors, appliances, or HVAC systems.
- Do not remove or bypass any LED Driver or Transformer that is provided with the fixture, and do not replace or substitute with another power supply.
- Remote LED Driver or Transformer installation must be done by a licensed electrician and in accordance with local codes. Remote installations should be in an accessible location, as close to the fixture as possible.
- Fixtures must be wired in parallel on independent leads; do not "daisy chain" multiple fixtures together or wire them in series.
- All factory-made splices and connections must remain intact. LED circuits are carefully designed and built, and improper connections may damage the fixture.
- The ends of coaxial pendant cords have been precisely stripped and split at the factory and must not be field cut. Excess cord or cable should be neatly coiled and reserved in the fixture canopy.
- Any mounting hardware is provided for your convenience and should be used with discretion. Always use the appropriate hardware for the mounting surface.

Assembly Instructions

INSTRUCTIONS D'INSTALLATION

1-Light Round Canopy Kit

Important

- Always disconnect the power before installing or replacing bulbs and before cleaning or other maintenance.
 - Consult a qualified, licensed electrician to ensure correct branch circuit conductor.
- Consulter un électricien qualifié pour vous assurer que les conducteurs de la dérivation sont adéquats.*

1. Shut off power to the outlet box (A).
2. Refer to the corresponding pendant cordset assembly instructions for any pendant preparations steps (if applicable).
2. Determine height at which the pendant is to be hung. Use the screwdriver to loosen the slotted set screw (B). Adjust height of cord. Tighten the set screw to set. Reserve extra cord in the canopy (C). If shortening of the cords is necessary, refer to Appendix A
3. Make appropriate electrical connections using wire nut:
 - a. Connect the LED driver's (D) live wire (black) to the live outlet box wire.
 - b. Connect the LED driver's (D) neutral wire (white) to the neutral outlet box wire.
 - c. Connect the canopy's ground wire (green or uncoated) to the ground outlet box wire. If no ground is present in outlet box, connect canopy's ground wire to the mounting plate (E) using the green screw (included).
 - d. Connect the fixture inner stranded conductor to the positive (+) driver output wire and connect the fixture outer braided conductor to the negative (-) driver output wire.
 - e. Carefully place connections and LED driver in outlet box.
4. Attach the mounting plate (E) to the outlet box (A), secure with outlet box screw (F).
5. Attach canopy (C) to the mounting plate (E), secure with canopy screws (G).
6. Complete fixture assembly per the corresponding pendant assembly instructions.

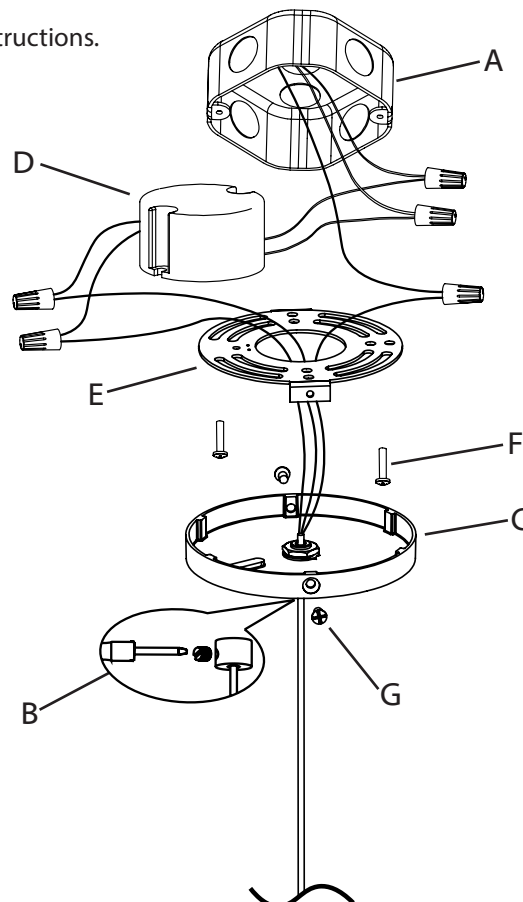

Note

- The outlet box must be at least 4" DIA and 1.5" deep to fit the LED driver.
- See markings on LED driver for compatible dimmer types.

Care Instructions

- **Dusting:** Use a clean, dry cloth.
- **Cleaning:** To protect the finish, avoid any harsh abrasives or chemicals.

Assembly Instructions

CST.3081.xx-xx

INSTRUCTIONS D'INSTALLATION

Parisone Series - Cordset

Important

- **Always disconnect the power before installing or replacing parts and before cleaning or other maintenance.**
- **Consult a qualified, licensed electrician to ensure correct branch circuit conductor.**
Consulter un électricien qualifié pour vous assurer que les conducteurs de la dérivation sont adéquats.

1. Shut off power to the outlet box.
2. Install canopy and spreader (if applicable) using the corresponding assembly instructions.
3. Screw glass (A) and diffuser (B) into fixture (C).
4. Restore power to the fixture.

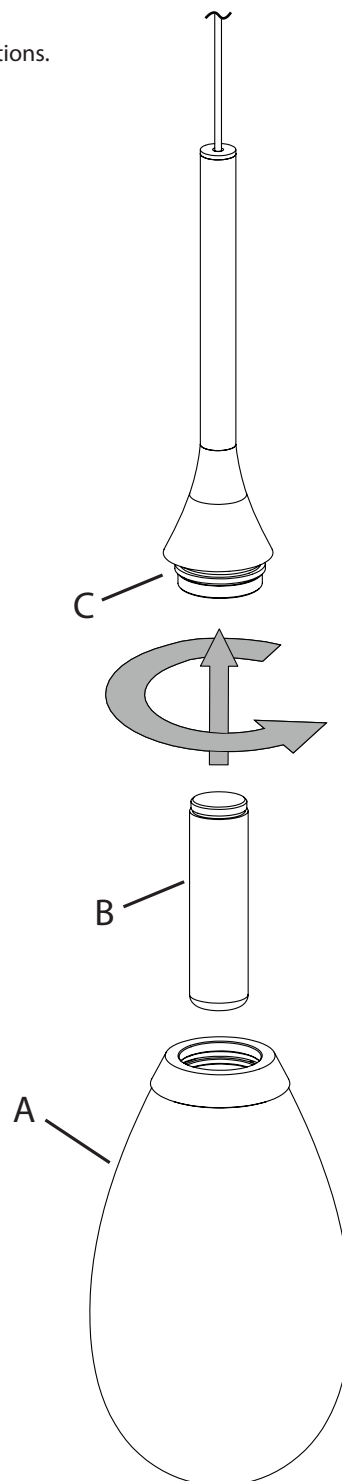

Care Instructions

- **Dusting: Use a clean, dry cloth.**
- **Cleaning: To protect the finish, avoid any harsh abrasives or chemicals.**

Coax Splicing

Assembly Instructions

INSTRUCTIONS D'INSTALLATION

FAILURE TO FOLLOW THESE INSTRUCTIONS WILL VOID THE WARRANTY

Coaxial Power Cord:

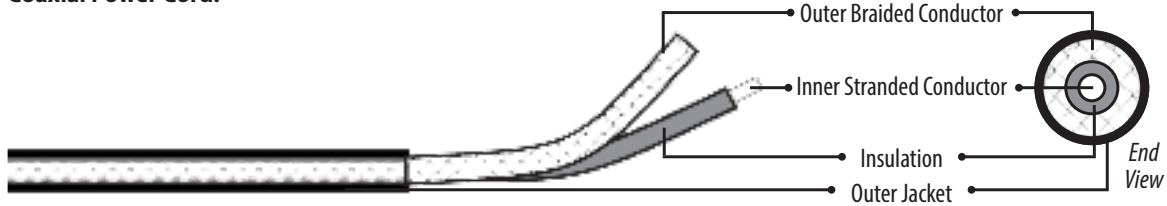

If field-cutting is required, please follow the below instructions:

1. Make a 1" slice along the length of the cord's outer jacket (Fig. 1). **CAUTION: Do not cut through the outer braided conductor.**
2. Carefully strip the outer jacket of the cord and keep the outer braided conductors intact (Fig. 1).
3. Slide the outer braided conductor back to create a bulge and reveal the inner stranded conductor (Fig. 2).
4. Bend the cord to create an opening through the bunched-up portion of outer braided conductor, then pull out the inner stranded conductor (Fig. 3)
5. Twist together the outer braided conductor to form the negative wire of the fixture, then strip 5/8" off the end of the inner stranded conductor to form the positive wire of the fixture (Fig. 4).
6. Re-splice all power cords.

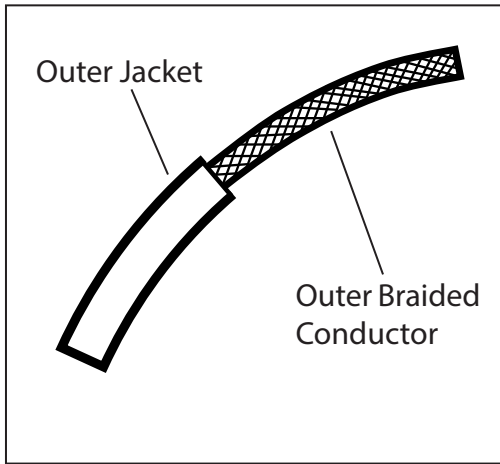

Fig. 1

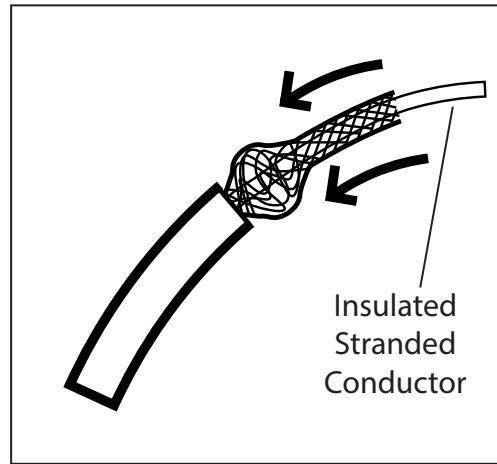

Fig. 2

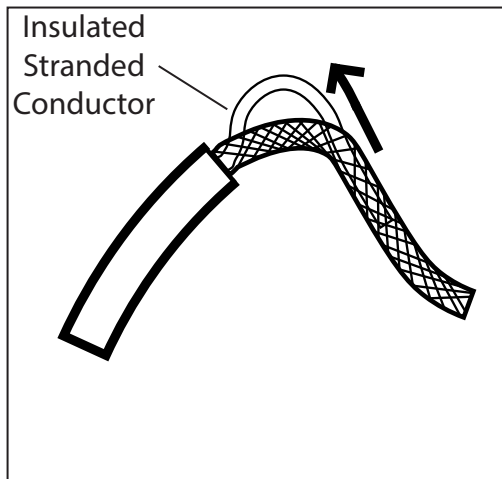

Fig. 3

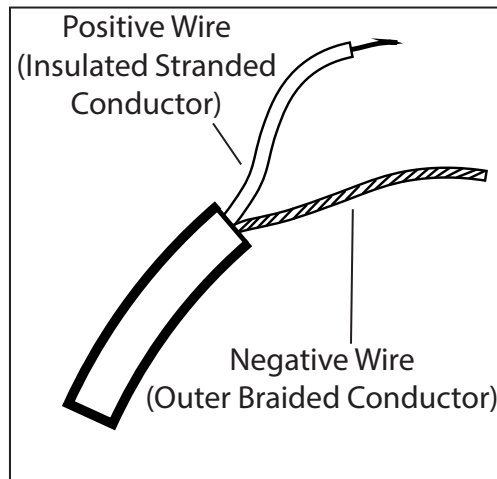

Fig. 4