

LED Product Information and Warnings

Important

- **Always disconnect the power before installing or replacing bulbs and before cleaning or other maintenance.**
- **Consult a qualified, licensed electrician to ensure correct branch circuit conductor.**
- Please read all included assembly instructions and warnings carefully before installation. Contact Customer Service if you have any questions or concerns. Before installation, please confirm that the fixture is compatible with your supply voltage and dimming system, if present.
- LEDs are highly sensitive electronic devices, and must be treated with care. Do not open any factory sealed compartments, and avoid touching the LEDs with your hands or any object.
- Although all our fixtures are equipped with protective devices, LED fixtures are vulnerable to power surges and supply variations. Do not install LED fixtures on the same circuit as any motors, appliances, or HVAC systems.
- Do not remove or bypass any LED Driver or Transformer that is provided with the fixture, and do not replace or substitute with another power supply.
- Remote LED Driver or Transformer installation must be done by a licensed electrician and in accordance with local codes. Remote installations should be in an accessible location, as close to the fixture as possible.
- Fixtures must be wired in parallel on independent leads; do not "daisy chain" multiple fixtures together or wire them in series.
- All factory-made splices and connections must remain intact. LED circuits are carefully designed and built, and improper connections may damage the fixture.
- The ends of coaxial pendant cords have been precisely stripped and split at the factory and must not be field cut. Excess cord or cable should be neatly coiled and reserved in the fixture canopy.
- Any mounting hardware is provided for your convenience and should be used with discretion. Always use the appropriate hardware for the mounting surface.

November 15, 2019

CPY.003.xx

Assembly Instructions

INSTRUCTIONS D'INSTALLATION

3-Light Round Canopy Kit

Important

- Always disconnect the power before installing or replacing bulbs and before cleaning or other maintenance.
 - Consult a qualified, licensed electrician to ensure correct branch circuit conductor.
- Consulter un électricien qualifié pour vous assurer que les conducteurs de la dérivation sont adéquats.*

1. Shut off power to the outlet box (A).
2. Refer to the corresponding pendant cordset assembly instructions for any pendant preparation steps (if applicable).
3. Determine the height at which each pendant is to be hung. Use the screwdriver (B) to loosen the set screw (C). Feed the power cords (D) through the bushings (E) on the canopy (F). Adjust the cord (D) to the desired length. Tighten the set screw to set.
4. Connect the fixture wires to the lever nuts (G) by pulling up on the lever for an empty slot (Fig. 1), inserting the wire, and pushing the lever back down to lock. The inner stranded conductor (H) and the outer braided conductor (J) on each cord (D) must be connected to separate lever nuts, as shown (Fig. 2). Reserve extra cords (D) and lever nuts (G) in the canopy (F). If shortening of the cords is necessary refer to Appendix A.
5. Attach cross bar (L) to the outlet box (A), secure with outlet box screws (M).
6. Make appropriate electrical connections using wire nuts:
 - a. Connect the LED driver's (K) live wire (black) to the live outlet box wire.
 - b. Connect the LED driver's neutral wire (white) to the neutral outlet box wire.
 - c. Connect the fixture's ground wire (green or uncoated) to the ground outlet box wire.
 - d. Carefully place connections and LED driver in the canopy.
7. Attach canopy (F) to nipple (N), secure with washer and finial (P).
8. Complete fixture assembly per the corresponding pendant assembly instructions.

Note

- See marking on the LED Driver for compatible dimmer types.

Care Instructions

- **Dusting:** Use a clean, dry cloth.
- **Cleaning:** To protect the finish, avoid any harsh abrasives or chemicals.

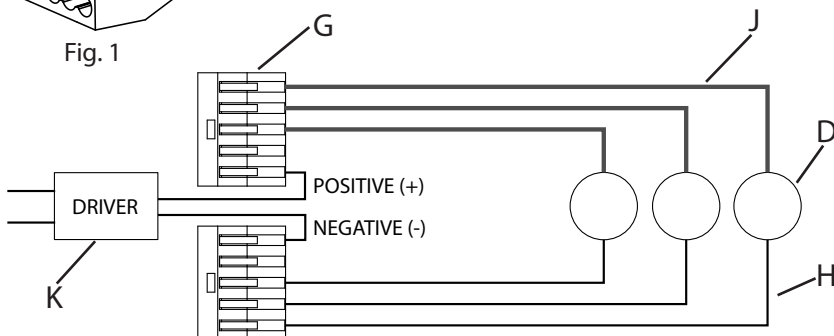
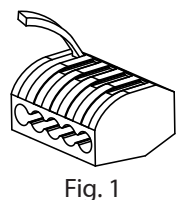
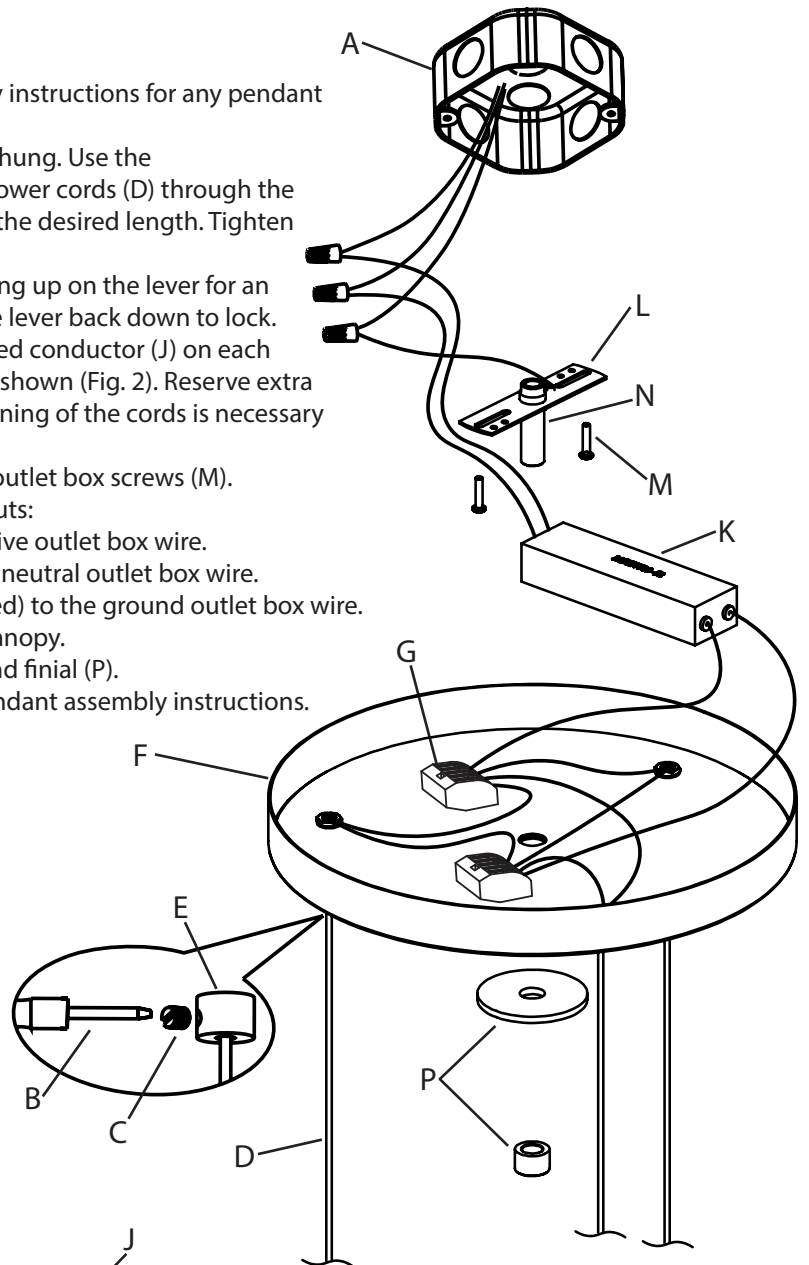

Fig. 2



Assembly Instructions

CST.3081.xx-xx

INSTRUCTIONS D'INSTALLATION

Parisone Series - Cordset

Important

- **Always disconnect the power before installing or replacing parts and before cleaning or other maintenance.**
- **Consult a qualified, licensed electrician to ensure correct branch circuit conductor.**
Consulter un électricien qualifié pour vous assurer que les conducteurs de la dérivation sont adéquats.

1. Shut off power to the outlet box.
2. Install canopy and spreader (if applicable) using the corresponding assembly instructions.
3. Screw glass (A) and diffuser (B) into fixture (C).
4. Restore power to the fixture.

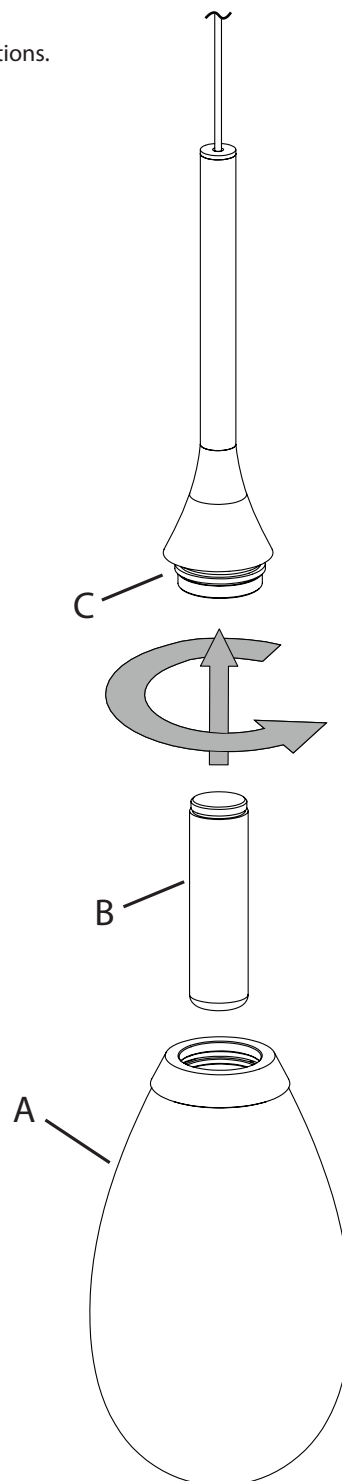

Care Instructions

- **Dusting: Use a clean, dry cloth.**
- **Cleaning: To protect the finish, avoid any harsh abrasives or chemicals.**

Coax Splicing

Assembly Instructions

INSTRUCTIONS D'INSTALLATION

FAILURE TO FOLLOW THESE INSTRUCTIONS WILL VOID THE WARRANTY

Coaxial Power Cord:

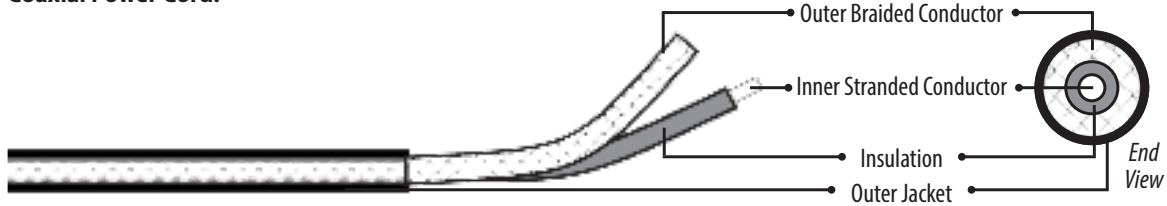

If field-cutting is required, please follow the below instructions:

1. Make a 1" slice along the length of the cord's outer jacket (Fig. 1). **CAUTION: Do not cut through the outer braided conductor.**
2. Carefully strip the outer jacket of the cord and keep the outer braided conductors intact (Fig. 1).
3. Slide the outer braided conductor back to create a bulge and reveal the inner stranded conductor (Fig. 2).
4. Bend the cord to create an opening through the bunched-up portion of outer braided conductor, then pull out the inner stranded conductor (Fig. 3)
5. Twist together the outer braided conductor to form the negative wire of the fixture, then strip 5/8" off the end of the inner stranded conductor to form the positive wire of the fixture (Fig. 4).
6. Re-splice all power cords.

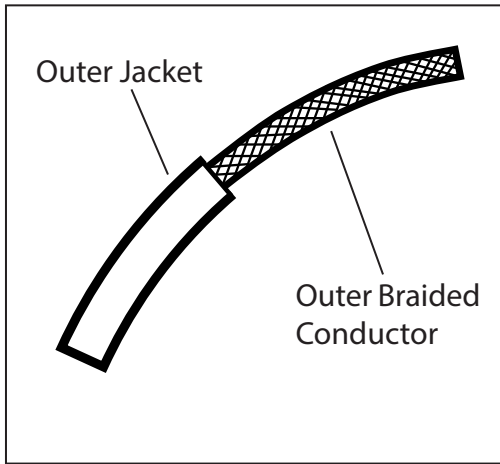

Fig. 1

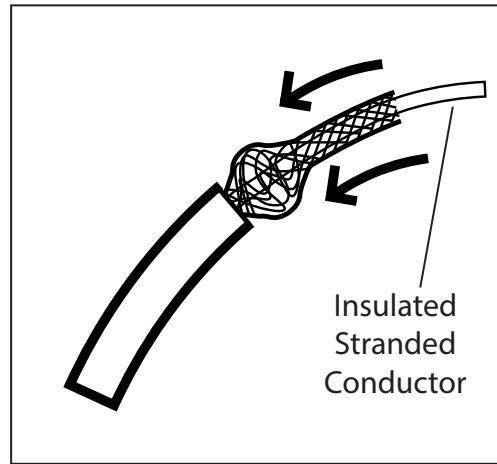

Fig. 2

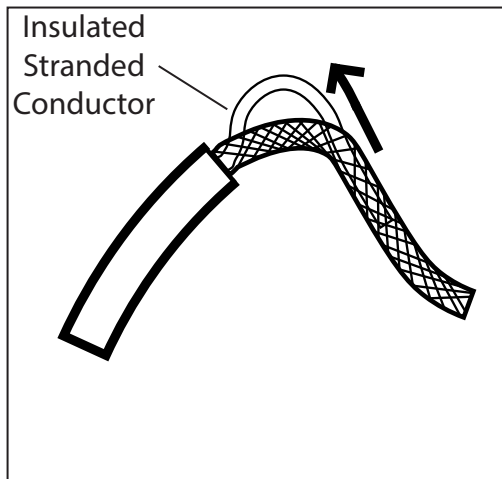

Fig. 3

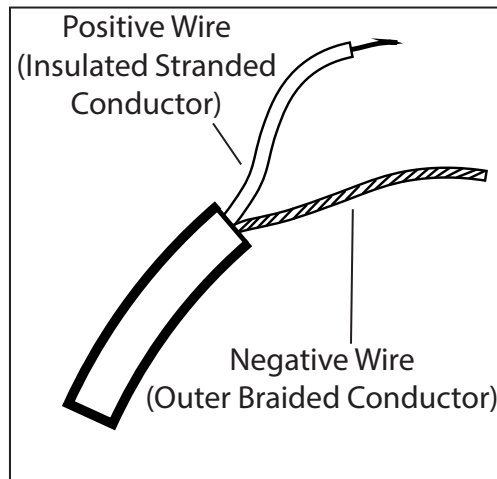

Fig. 4