

Installation Guide

Picture 1

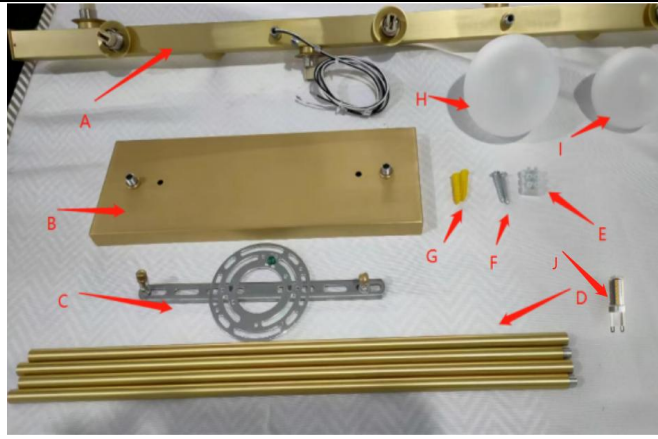

Parts List: A*1, B*1, C*1, D*4, E*1, F*2, G*2, H*3(100mm),I*6(80mm),J*9

Picture 2

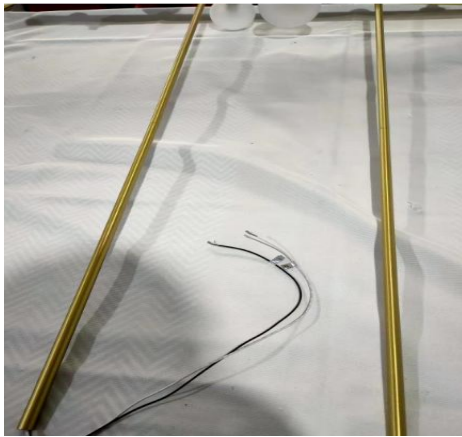

Step 1: Install pole D as shown.

Picture 3

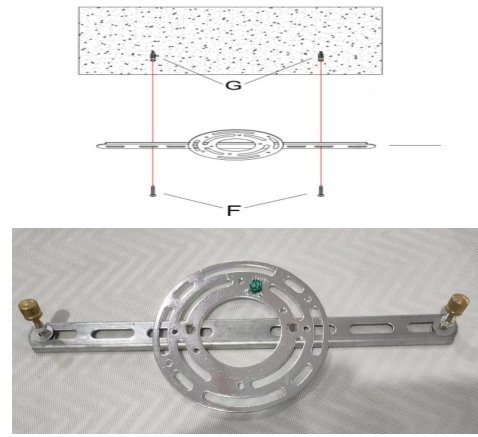

Step 2: Fix the hanging plate C to the ceiling.

Picture 4

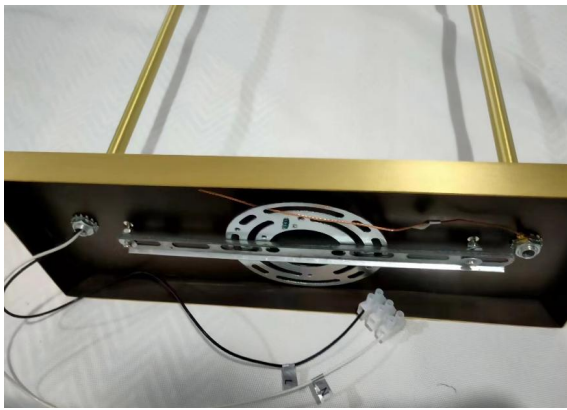

Step 3: Install the ceiling plate B and the whole lamp body on the hanging board.

Picture 5



Step 4: Install light bulbs.

Picture 6

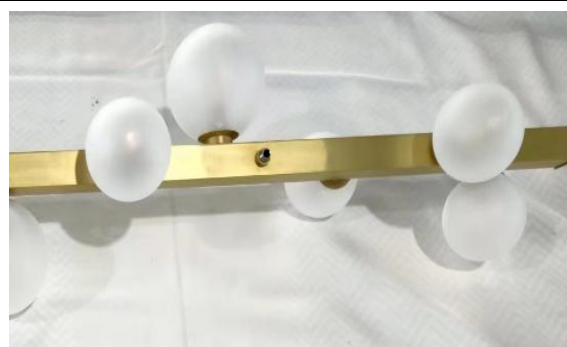

Step 5: Install the lampshade.

Picture 7



Completion.