

## Wall & Display Shelves

# Contents

## Before Use

General Guidelines..... 03

Warning..... 03

Material Properties..... 03

## Installation Guide

Assembly Instructions..... 03

Parts List & Accessories List..... 04

Exploded Views..... 05

Installation Steps..... 06

## Operation

USE & MAINTAINANCE..... 08

## General Guidelines

Please read the following instructions carefully and use the product accordingly.

Please keep this manual and hand it over when you transfer the product.

Product is intended for indoor use only. It must be assembled and used according to the instructions. The seller does not accept any responsibility for damage or injury resulting from improper assembly or use.

This summary may not include every detail of all variations and considered steps.

Please contact us when further information and helps are needed.

## Warning

Children are not allowed to assemble the product.

During assembly, keep any small part out of reach of children as they may be fatal if swallowed or inhaled.

Children are not allowed to stand, climb or play on the product to avoid serious bodily injury by the toppling.

Keep plastic packing bags out of reach of children to avoid any potential danger, such as suffocation.

Avoid sharp objects and corrosive chemicals to prevent damage to the product or bodily injury.

## Material Properties

### 1. Solid Wood

Trees will have a unique texture, scar, color and other natural marks during their growth. These elements constitute the natural beauty of wood. After being made into furniture, there will be slight discoloration when viewed under different light and different angles. That is because different grain minerals and light intensity affect vision, which is a normal phenomenon.

### 2. Marble and Sintered Stone

The pattern of marble and sintered stone is unique to each piece. Due to the characteristics of the material, there is no guarantee that the pattern of each piece will be consistent with the pattern seen at the time of purchase.

## Assembly Instructions

· Read these instructions carefully and keep for future reference. Refer to parts inventory for guidance, and ensure you have all pieces before starting.

· **When assembling place all parts on a soft, clean, and flat surface such as a carpet to prevent scratches.**

· **During assembly, align all screws with the corresponding pre-drilled holes first and then tighten them one by one.**



TIME



2 People

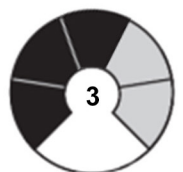

DIFFICULTY

**Do not discard any contents until after assembly is complete to avoid accidentally discarding small parts or hardware.**

### TOOLS YOU MAY NEED



**Note: It is recommended that installation of the product be done by a qualified licensed furniture assembler.**

# Parts List & Accessories List

Ax3

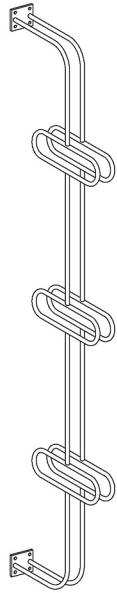

Bx3

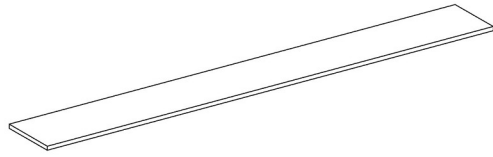

Cx24

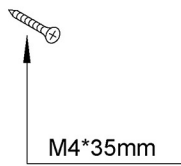

Dx24



Ex18

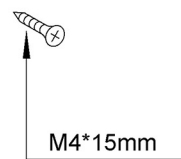

# Exploded Views

## EXPLODED

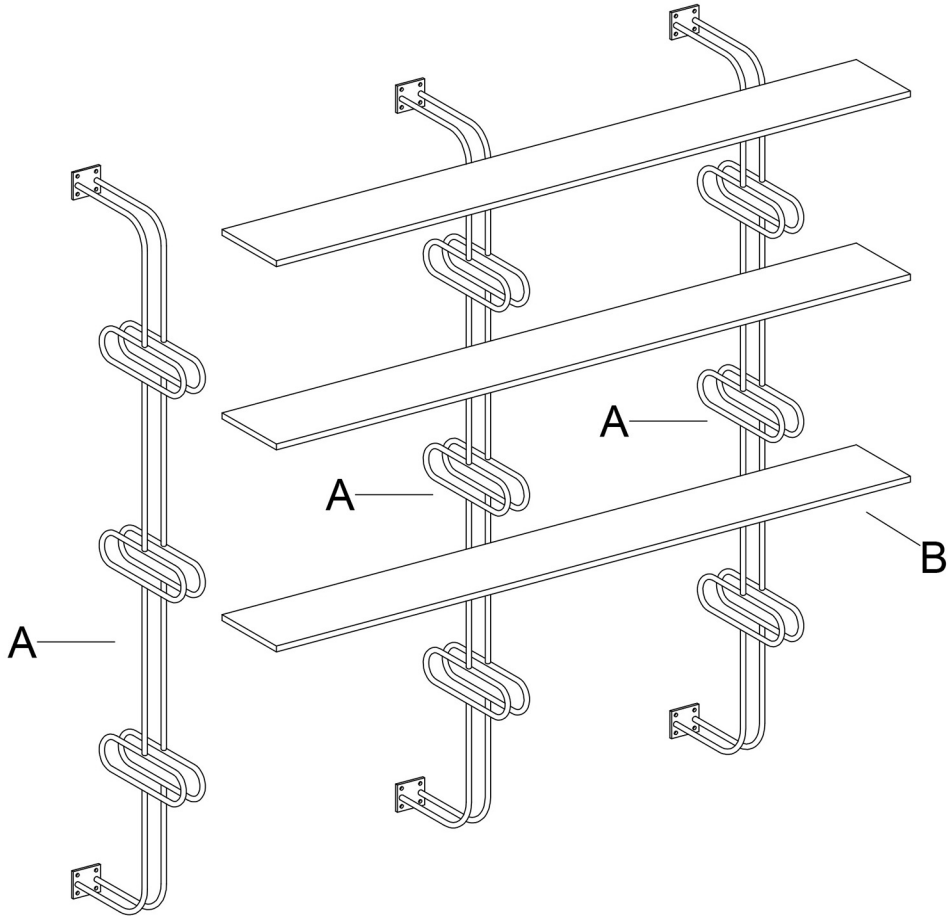

## COMPLETE

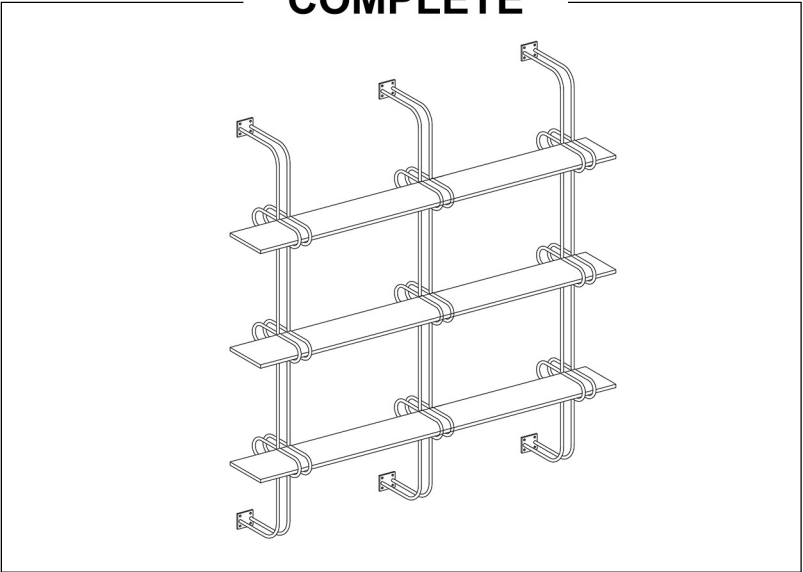

# Installation Steps

## Step 1

C  x24

D  x24

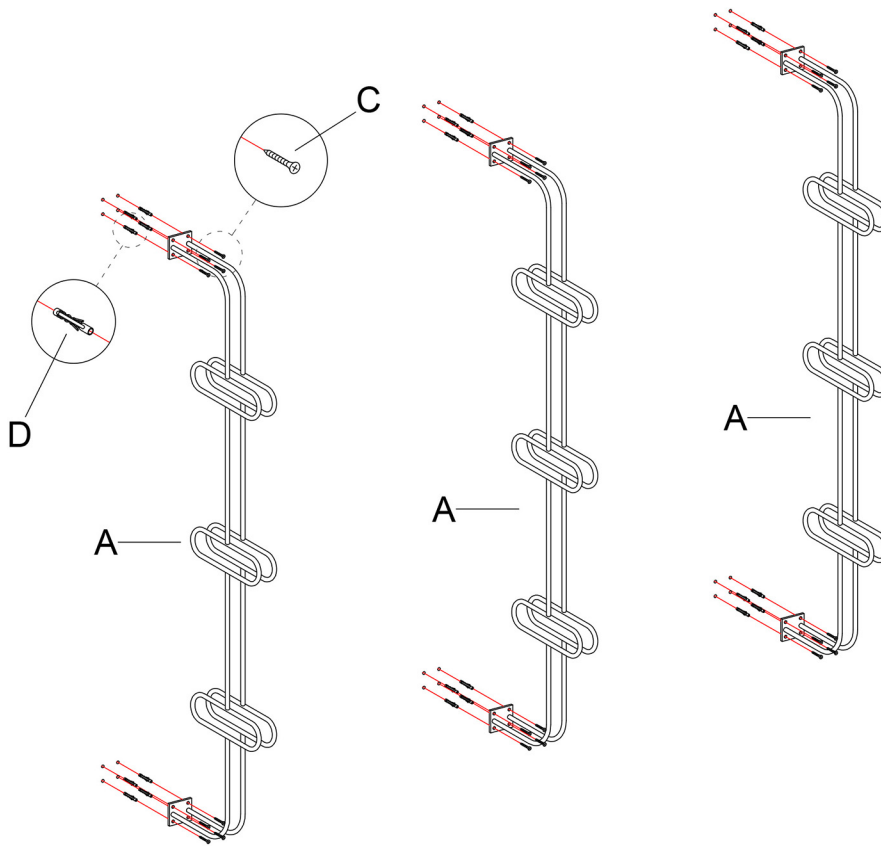

## Step 2

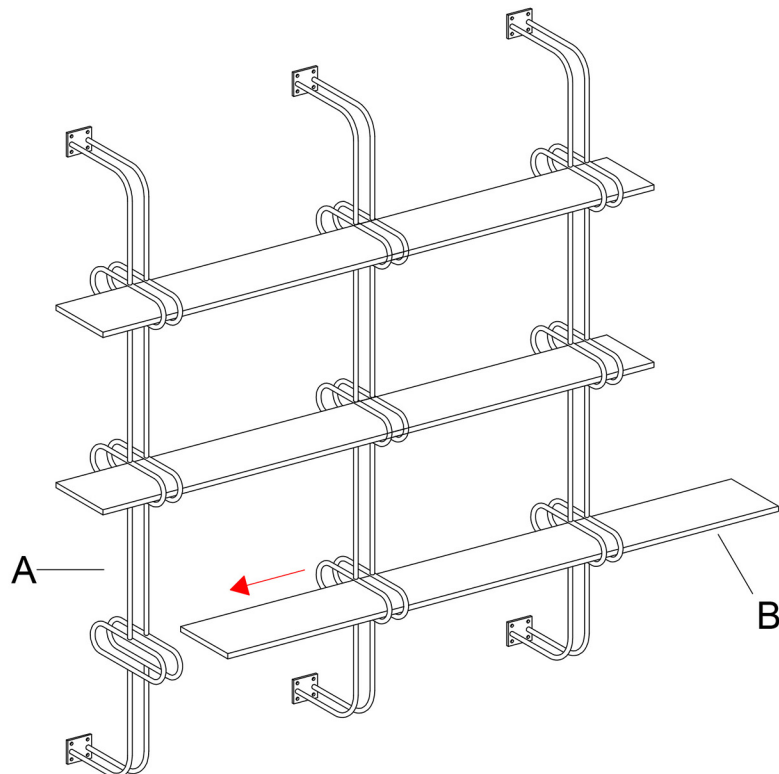

# Installation Steps

## Step 3

E  x18

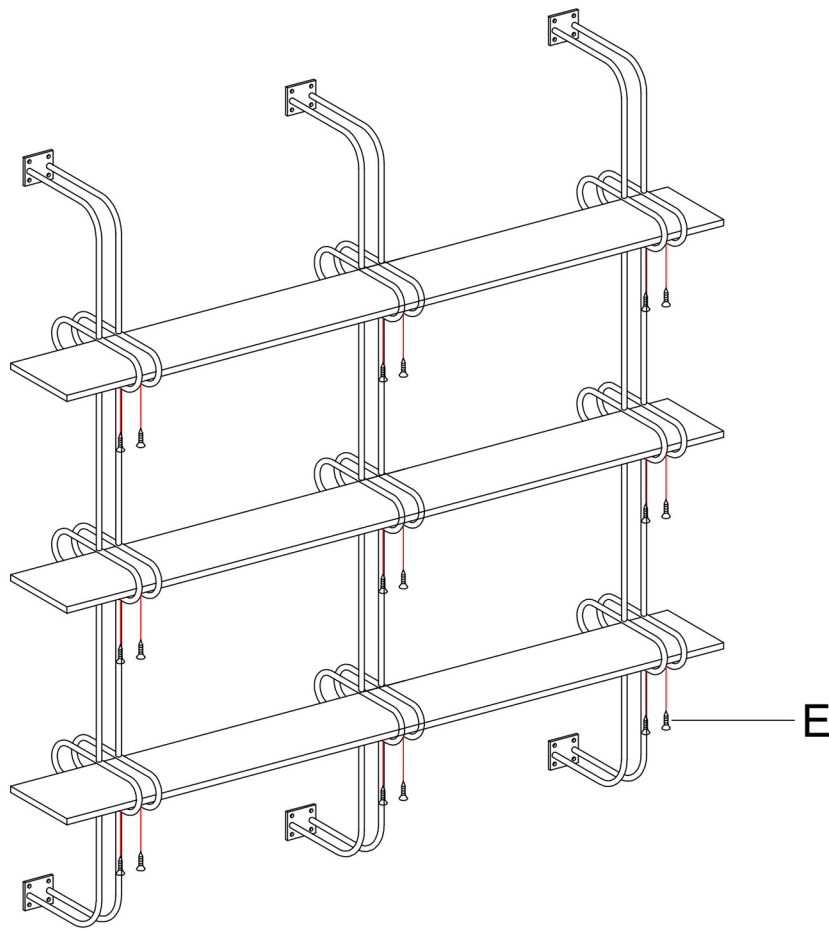

## USE & MAINTAINANCE

1. Keep the furniture vacant for half a month before use, and maintain good indoor ventilation to eliminate the residual odor in furniture surface coating.
2. Place the objects smoothly, Heavier objects should be placed at the bottom (layer) of the furniture to avoid the furniture from tipping over.
3. Do not push hard objects directly on the furniture to avoid scratching the surface of the furniture.
4. Do not expose the furniture to sunlight for a long time or place the furniture close to the heating equipment, which can cause localized discoloration and fading.
5. Please avoid long-term exposure to humid environment to prevent mildew for wooden product.
6. Do not let items that are flammable and oxidizing touch the surface of the furniture, which may cause chemical reactions and damage to the furniture finishing.
7. Liquid spills should be removed immediately. Using a soft clean cloth, blot the spill gently. Avoid rubbing.
8. Screws may become loose during long-term use. If necessary, re-tighten them to ensure stability and security.