

Bed

Contents

Before Use

General Guidelines.....	03
Warning.....	03
Material Properties.....	03

Installation Guide

Assembly Instructions.....	04
Parts List.....	05
Accessories List.....	06
Exploded Views.....	07
Installation Steps.....	08

Operation

Use and Maintenance.....	10
Trouble Shooting.....	12

General Guidelines

- Please read the following instructions carefully and use the product accordingly.
- Please keep this manual and hand it over when you transfer the product.
- Product is intended for indoor use only. It must be assembled and used according to the instructions. The seller does not accept any responsibility for damage or injury resulting from improper assembly or use.
- This summary may not include every detail of all variations and considered steps.
- Please contact us when further information and helps are needed.

Warning

- Children are not allowed to assemble the product. During assembly, keep any small part out of reach of children as they may be fatal if swallowed or inhaled.
- Do not allow children to play with the mechanism.
- Keep plastic packing bags out of reach of children to avoid any potential danger, such as suffocation.
- Avoid sharp objects and corrosive chemicals to prevent damage to the product or bodily injury.

Improper opening could damage the mechanism or the bar.

- Do not sit violently on the edges or jump on the futon.
- Remove the bed sheets and blankets before closing the bedspring.



Material Properties

1. Solid Wood

Trees will have a unique texture, scar, color and other natural marks during their growth. These elements constitute the natural beauty of wood. After being made into furniture, there will be slight discoloration when viewed under different light and different light and different angles. That is because different grain minerals and light intensity affect vision, which is a normal phenomenon.

2. Genuine Leather

Leather offer an ideal level of comfort both during the hot months and the cold months thanks to its properties of transpiration and flexibility.

Follow are some natural characteristics you may find on product:



Low Graining



Closed Scar



Closed Scars



Grain Difference



Wrinkle



Insect Bites



Veining



Differences In Tone

3. Leather and Cloth

Colour difference may occur between the product you seen at the time of purchase and the actual delivered one. Owing to dye technology, no guarantee of absolute uniformity on colour can be given.

Assembly Instructions

· Read these instructions carefully and keep for future reference. Refer to parts inventory for guidance, and ensure you have all pieces before starting.

· **When assembling place all parts on a soft, clean, and flat surface such as a carpet to prevent scratches.**

· **During assembly, align all screws with the corresponding pre-drilled holes first and then tighten them one by one.**



TIME



2 People

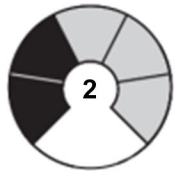

DIFFICULTY

Do not discard any contents until after assembly is complete to avoid accidentally discarding small parts or hardware.

TOOLS YOU MAY NEED

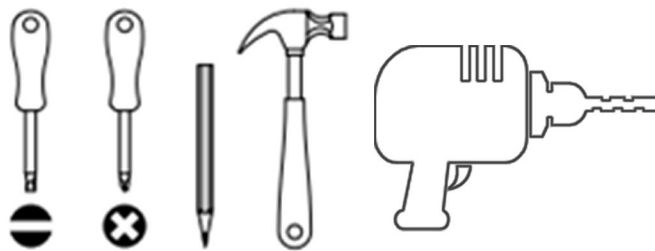

Note: It is recommended that installation of the product be done by a qualified licensed furniture assembler.

Parts List

Ax1

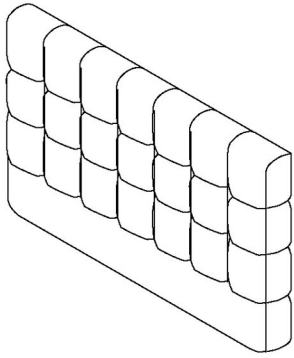

Bx2

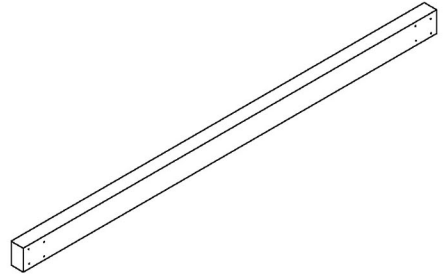

Cx1

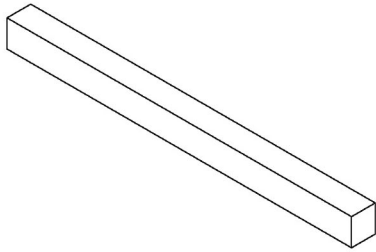



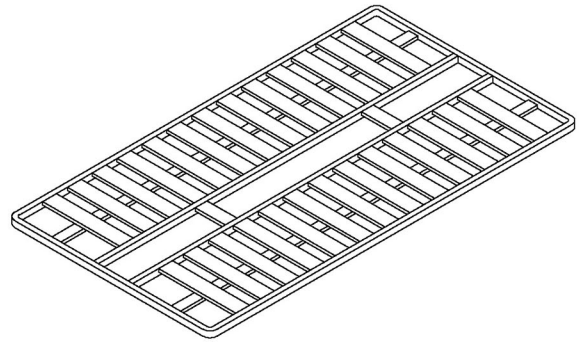

Dx1

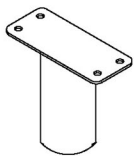

Ex2

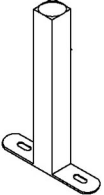
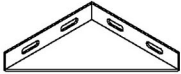

Accessories List

<p>Fx8</p>  <p>M4*35mm</p>	<p>Gx32</p>  <p>M8*25mm</p>	<p>Hx8</p> 
<p>Ix10</p>  <p>M8*50mm</p>	<p>Kx2</p> 	<p>Lx4</p> 
<p>Mx8</p> 		

Exploded Views

EXPLODED

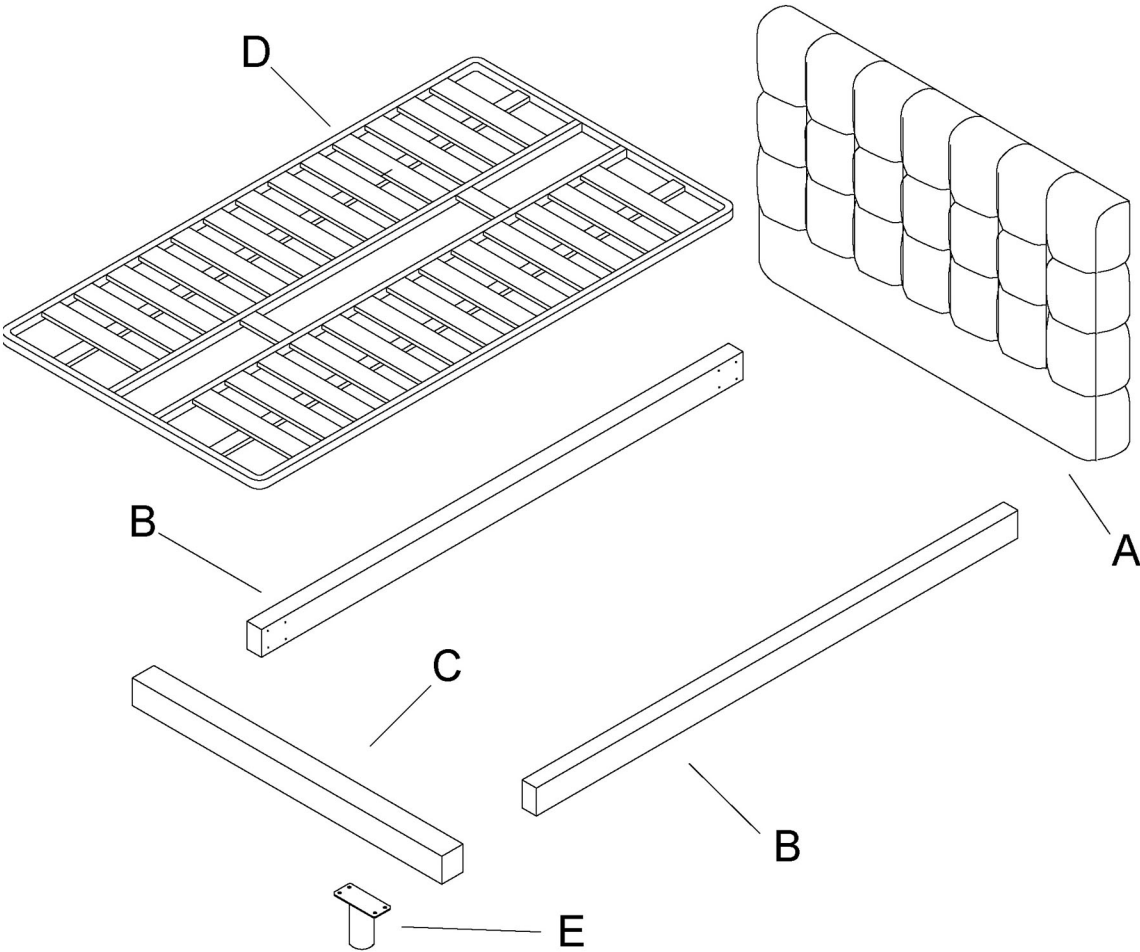

COMPLETE

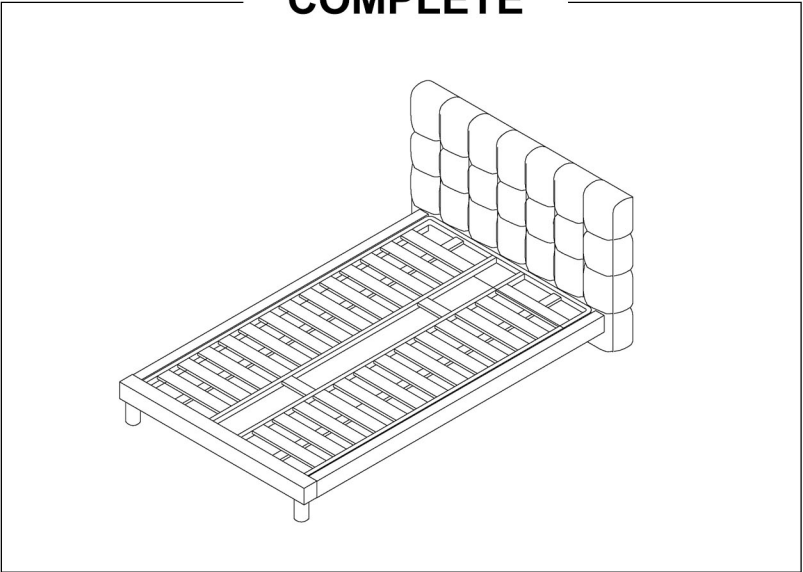

Installation Steps

Step 1

F  x8

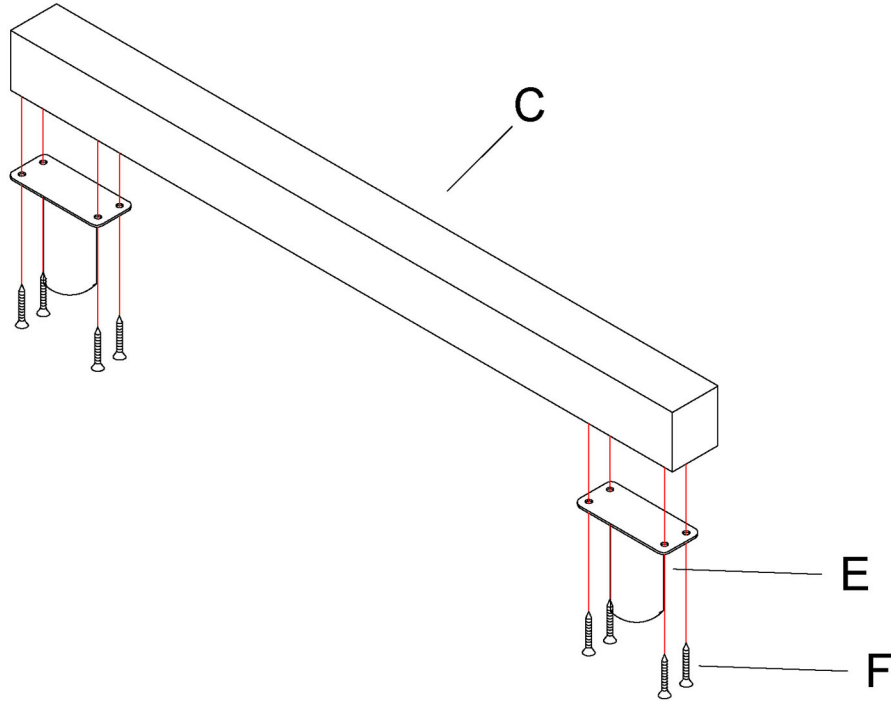

Step 2

G  x32

M  x8

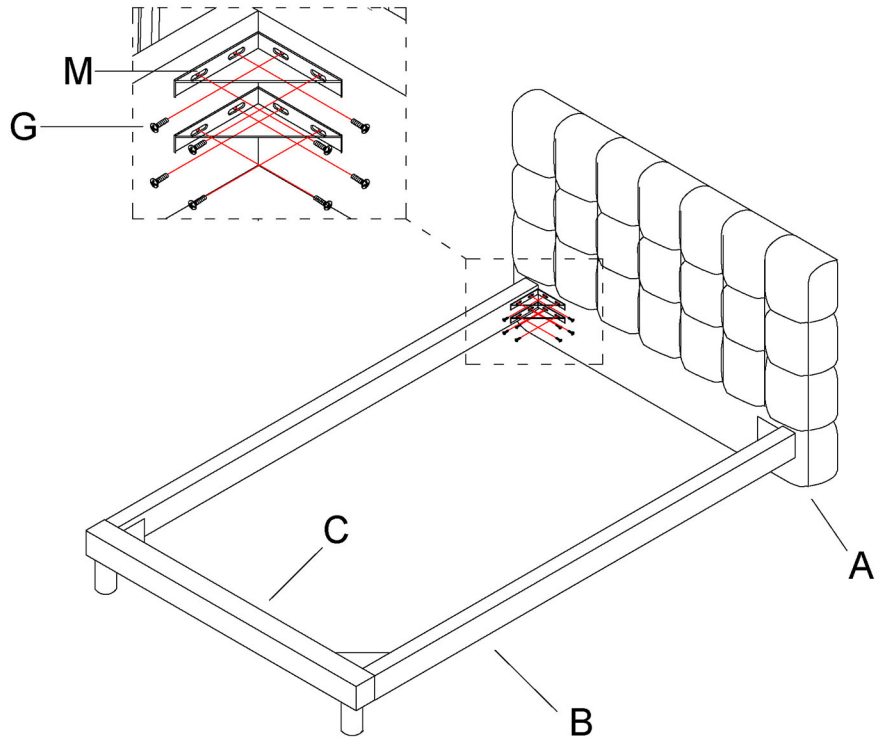



Installation Steps

Step 3

H  x8

I  x10

K  x2

L  x4

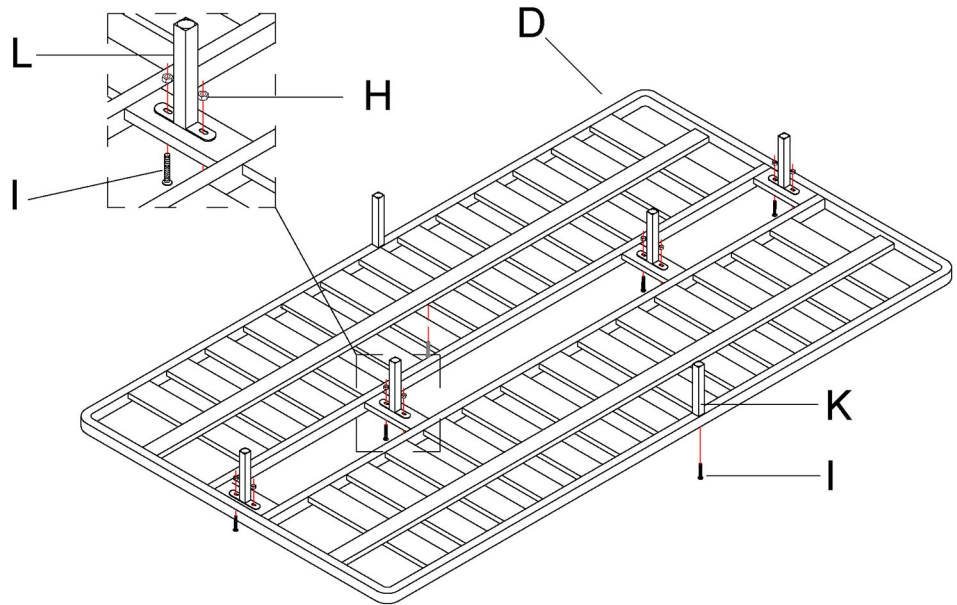

Step 4

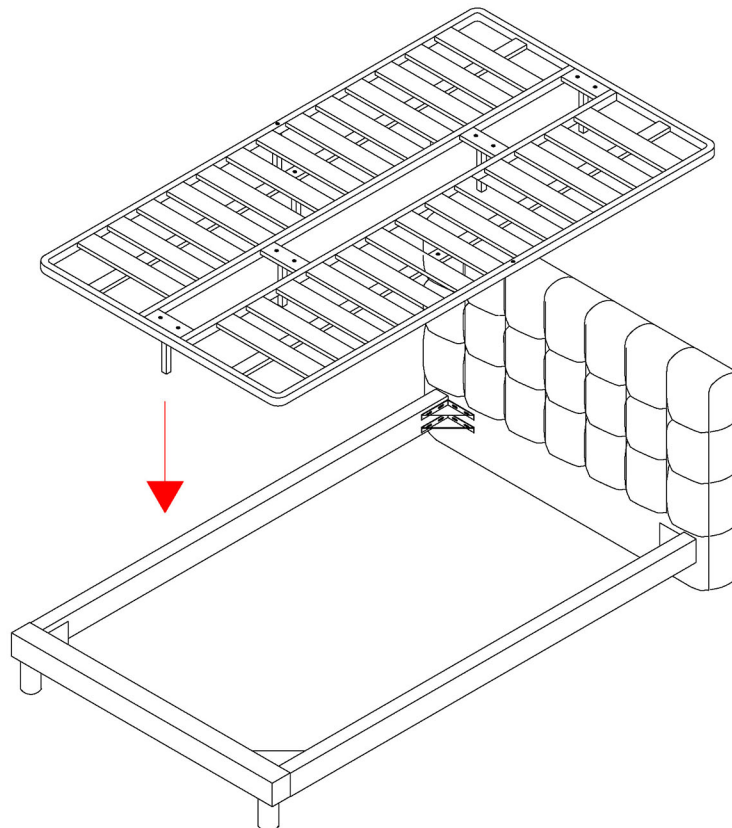

Use and Maintenance

1. When a new product is delivered to your home, please always keep a good indoor ventilation, which helps the rapid dissemination of smell from the product itself. If not for immediate use, please unpack and place it in a dry and ventilated environment to prevent mildewing.
2. When unpack the wrapping, do not use any pointed or sharp object to avoid any scratch or damage to the covering appearance.
3. The product must be positioned straight on the horizontal and even floor.
4. Avoid exposing the product to direct sunlight or to powerful lamps to ensure the colour of the covering remains bright.
5. Avoid any corrosive chemical solvent or inferior detergent contacting with the covering, which may result in fading aging, cracking and other damages to the covering.
6. Position the product at least 40cm from heat sources such as heater, air conditioner or radiator to prevent the leather from hardening and chapping.
7. Dust the product by a clean, soft and non-abrasive white cloth before usage.
8. Avoid any pointed or sharp object contacting with the product to prevent the covering from the possible scratches and damage(e.g.scissors or knives). Be careful to prevent your jewelry, buckle and sharp accessories on your clothes from hooking or piercing the covering.
9. Take good care of your pets to avoid any damage to the product caused by their clawing and biting.
10. If the uncut thread ends are found, do not pull them by hand, but use the scissors to trim them.
11. Do not put the newspaper onto the product, otherwise the ink would be dyed onto the covering, leaving an indelible stain. When storing the product for a long time without using, clean and cover it with dust proof packing materials and then place it in a dry and airy environment indoors.

Special instruction

1.FORMATION OF HOLLOWS

The hardness of the seat becomes softer with using time, which is a normal process for any type of upholstery. For equal hardness, it is important to change the seating position from time to time. Otherwise the folds and hollows may occur on one side. It is also recommended to always flap the seated parts

2.NON-COLOURFAST CLOTHING

In the case of light color covering, discolouration may be caused by non-colourfast clothing, like dark denims. And color transferred from dark color leather to clothing is also possible, This is the nature of dyed leathers and fabric, but not a product defect, and will not be accepted as a claim.

Cleaning

·**Daily maintenance:** use a soft and wrung towel often to wipe the fabric dust. The seam debris in the intersection of the back, armrests, and seat surface can be cleaned with a vacuum cleaner. When using a vacuum cleaner, do not use the brush head to prevent the woven threads on the textile fabric from being destroyed and becoming fluffy. It is recommended to use a small vacuum cleaner instead of a large suction, which may cause the threads to be torn. It is forbidden to use wet cloths, hard objects, or acidic and alkaline chemicals to touch the fabric, so as not to affect the surface quality and service life.

·**Regular maintenance:** generally, the maintenance should be once-a-quarter. After wiping the furniture surface with a clean soft cloth, leather fabrics shall be cleaned with special leather cleaner, to evenly coat the surface. Then, wipe it again with a clean soft cloth. Textile fabric shall be cleaned with a small amount of alcohol and wiped with a towel. It is suggested to use the appropriate chemical cleaners, such as Scotch, etc., but before using chemical agents, it is necessary to carefully read instructions, and do fade experiments. As for the cleaning agents, a special cleaning agent with anti-fouling agents is recommended, such as Scotch, etc. Besides, some silicone fogging agents with a dust effect can be sprayed once a month.

TYPE OF STAIN	CLEANING METHOD
Dry dirt	Brush delicately using a brush with softbristles or use a vacuum cleaner at medium power with care.
Soft drinks,tea,coffee, beer,wine,milk,jam	Rapidly remove the liquid from the surface by a dry and clean cloth or absorbent paper to avoid being absorbed.Then rub the stain lightly with a clean and damped cloth soaked in the water.
Greasy substance: oil,grease,butter,chocolate, cosmetic,ink	Promptly remove the stain gently by absorbent paper or absorptive cloth,applying minimal pressure to prevent the stain from entering the pores of the leather.Use a clean cloth, soaked in a very diluted solution of neutral soap,rubbing delicately.
Chewing gum,candle wax	Cool down the mark ice,folded in a cellophane bag,then gently remove the mark.If the mark is still visible,try to remove by a normal soft rubber eraser.

General rule:

1. To rub the stain, work delicately in circular direction, from the outside of the stain towards the center.
2. After rubbing, dry immediately with a clean and dry cloth. Let the product dry for several minutes before using or touching it. Do not dry the leather in direct sunlight or with a hair dryer.
3. If it is necessary for more accurate cleaning, use water and colourless, mild soap only.

Trouble Shooting

Symptoms	Cause Analysis	Cause Analysis
Sofas, soft beds, dining chairs, and leisure chairs are unstable and shake after being placed	Four feet are not evenly on the ground	Depending on the ground clearance, use suitable hard objects to level it (some conference chairs can adjust the height of the rubber pad on the sole of the foot to balance the chair body)
Inflexible use of furniture moving parts	Loose connection of moving parts or lack of lubricating oil	Retighten the connecting screws to make the connection firm
Armrest loose	Armrest screws loose	Tighten the connecting screws and add lubricating oil properly
Scratches and bumps on painted wood	Paint surface damaged	Touch it up with paint of the same color
Deformation of the foam	Caused by long term transportation of use	Using a steamer, gently apply steam to the affected area of the sofa, and then use your hands to reshape it. Be careful not to get the sofa too wet or to burn yourself with the steam.